

DT Series

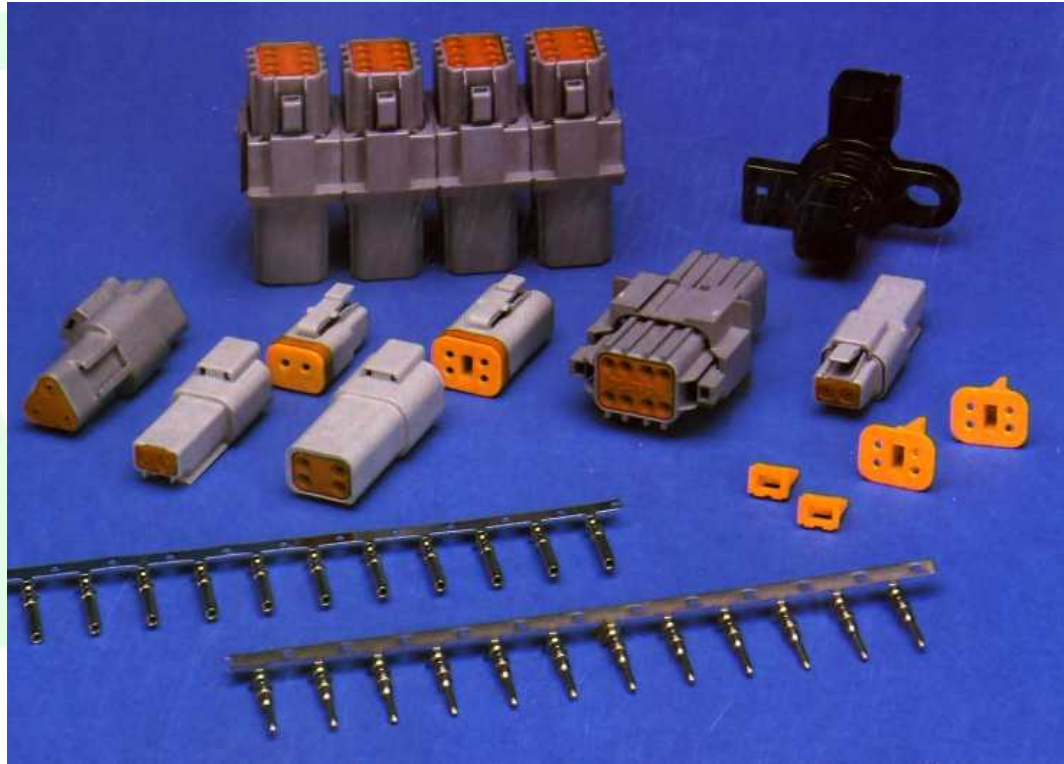

DEUTSCH
CONNECTORS
A Step Ahead



Industrial Products Division

DT Series

Features and Benefits

Introduction

Deutsch DT Series of environmentally-sealed connectors are designed specifically for cable to cable applications on the engine or transmission, under the hood, on the chassis or in the cab. Where signal level circuits in harsh environmental conditions, where even a small degradation in connection may be critical, the Deutsch DT Series general purpose connectors will provide the reliability and performance at the lowest cost.

Thermoplastic (-55°C to +125°C rated) housings and silicone seals are used to allow the connector to withstand conditions of extreme temperature and moisture. The connector may be employed with either solid-copper crimp type contacts for critical circuits or budget-minded stamped and formed contacts. In either selection, the spring action is designed in the socket and shrouded by a stainless steel hood that provides closed entry for positive axial alignment during mating, and eliminates probe damage from occurring. Contact insertion and withdrawal require no special tools and are retained in locked position by dielectric fingers, molded as an integral part of the housing. Contrasting colored secondary locks are assembled at the mating interfaces. If by chance the secondary locks are not properly seated during assembly, they will be pressed into locked position during the mating of the connector.

If you want your electrical system to be trouble free, providing years of service at the lowest cost...specify the Deutsch DT Series connector.



DT SERIES-4 contact arrangement shown above

Features

- Integral connector latch
- Rugged thermoplastic housing
- -55°C to +125°C operating temperature
- Available in 2, 3, 4, 6, 8 & 12 sizes
- Silicone seals
- Accepts AWG 18 thru 14 wire
- Crimp contacts with option of gold or nickel, solid or stamped
- Current rating: 13 amps all contacts
- Fail safe secondary locks
- Hand insertable/removable contacts
- Budget-minded

Benefits

- Tactile and audible coupling feedback
- Long service life
- Engine compartment rated
- Meets most harness design requirements
- Superior environmental seal
- Seals .088 to .145 dia. insulation
- Data transmission or power distribution terminals
- Meets most power requirements
- Reliable contact retention system
- No special tools required
- Low installation costs

*Specifications may change without notice.
Contact Deutsch IPD at 909/765-2250 for additional information.*



DT Series

Product Data - Ordering Information

Ordering Information

Connector Part Numbering System

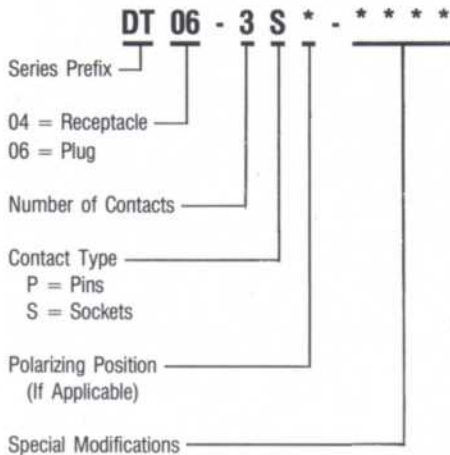

Secondary Lock Part Numbering System

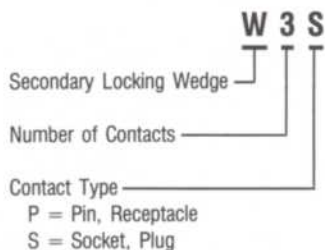

Contact Part Numbers

Solid - Crimp Type - Nickel Plated

0460-202-16141	PIN	16-18 AWG
0462-201-16141	SOC	16-18 AWG
0460-215-16141	PIN	14-16 AWG
0462-209-16141	SOC	14-16 AWG

Stamped & Formed Crimp Type - Nickel Plated
Strip Form (4000 Per Reel)

1060-16-0122	PIN	16-18 AWG
1062-16-0122	SOC	16-18 AWG
1060-14-0122	PIN	14-16 AWG
1062-14-0122	SOC	14-16 AWG

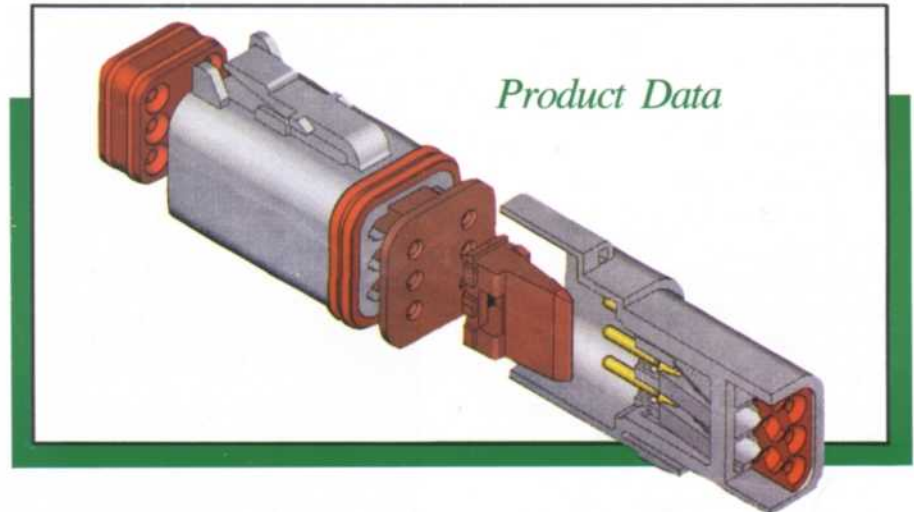

Material Specifications

Housings (Plug & Receptacle) - Thermoplastic
Seals - Silicone Elastomer
Secondary Locks - Thermoplastic
Contacts - Copper Alloy, Nickel Plated, Gold Optional

General Specifications

Dielectric Withstanding Voltage (Test Voltage):
Sea Level - 1500 VAC (rms)

Current Rating (Maximum):
No. 16 13 amps

Silicone Insert:
Front and rear silicone inserts are devoid of all organic matter.

ARC Resistance:
All dielectric materials withstand a minimum of 130 seconds per ASTM D-495.

Physical Shock:
No locking, unmating or other unsatisfactory result after 50g's in each of three mutually perpendicular planes.

Dielectric Strength:
1500 volts minimum.

Submersion:

Properly wired and mated connection will withstand immersion under three feet of water without loss of electronic qualities or leakage.

Vibration:

Maintains continuity and exhibits no mechanical or physical damage after vibration. 20 g's at 10-2000 Hz.

Temperature:

Operative at temperatures from -55°C to +125°C at rated current.

Contact Retention:

Contacts withstand a minimum load of 25 lbs. for size 16.

Thermal Shock:

No cracking, chipping or leaking after 5 test cycles from -55°C to +125°C.

Insulation Resistance:

1000 megohms minimum at 25°C.

Usable Wire Size:

No. 16 contacts - receive conductor AWG 14 thru 18. Rear insert will seal on smooth insulation from .088" to .145" O.D.

Durability:

No electrical or mechanical defects after 100 cycles of engagement and disengagement.

Contact Millivolt Drop:

No. 16 contacts -100 millivolt drop* using 16 AWG wire. Test current 13 amps.

*Less drop through wire.

Specifications may change without notice.
Contact Deutsch IPD at 909/765-2250 for additional information.



DT Series

Contact Arrangements

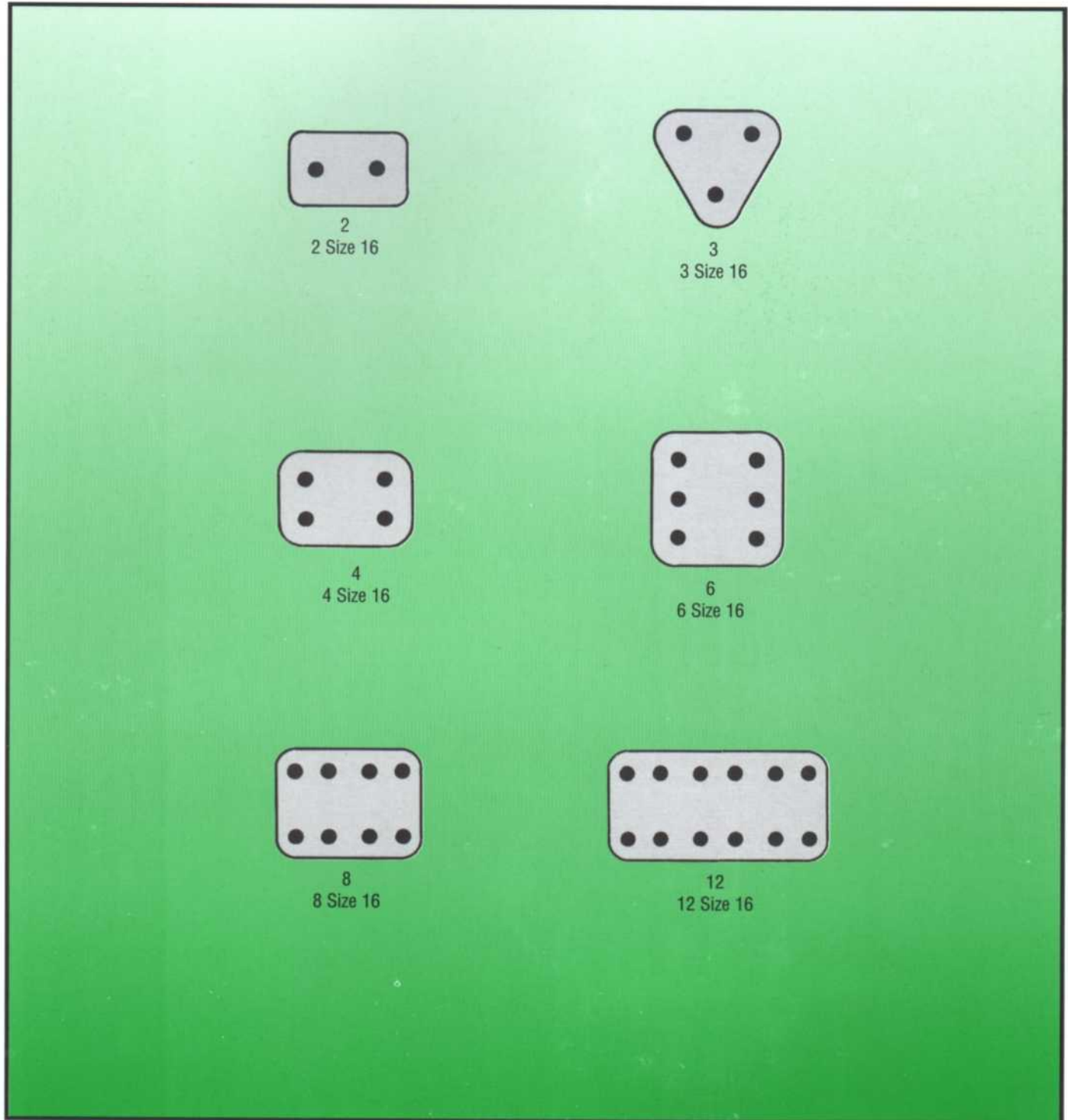

*Specifications may change without notice.
Contact Deutsch IPD at 909/765-2250 for additional information.*



DT Series

Plug Cable To Cable

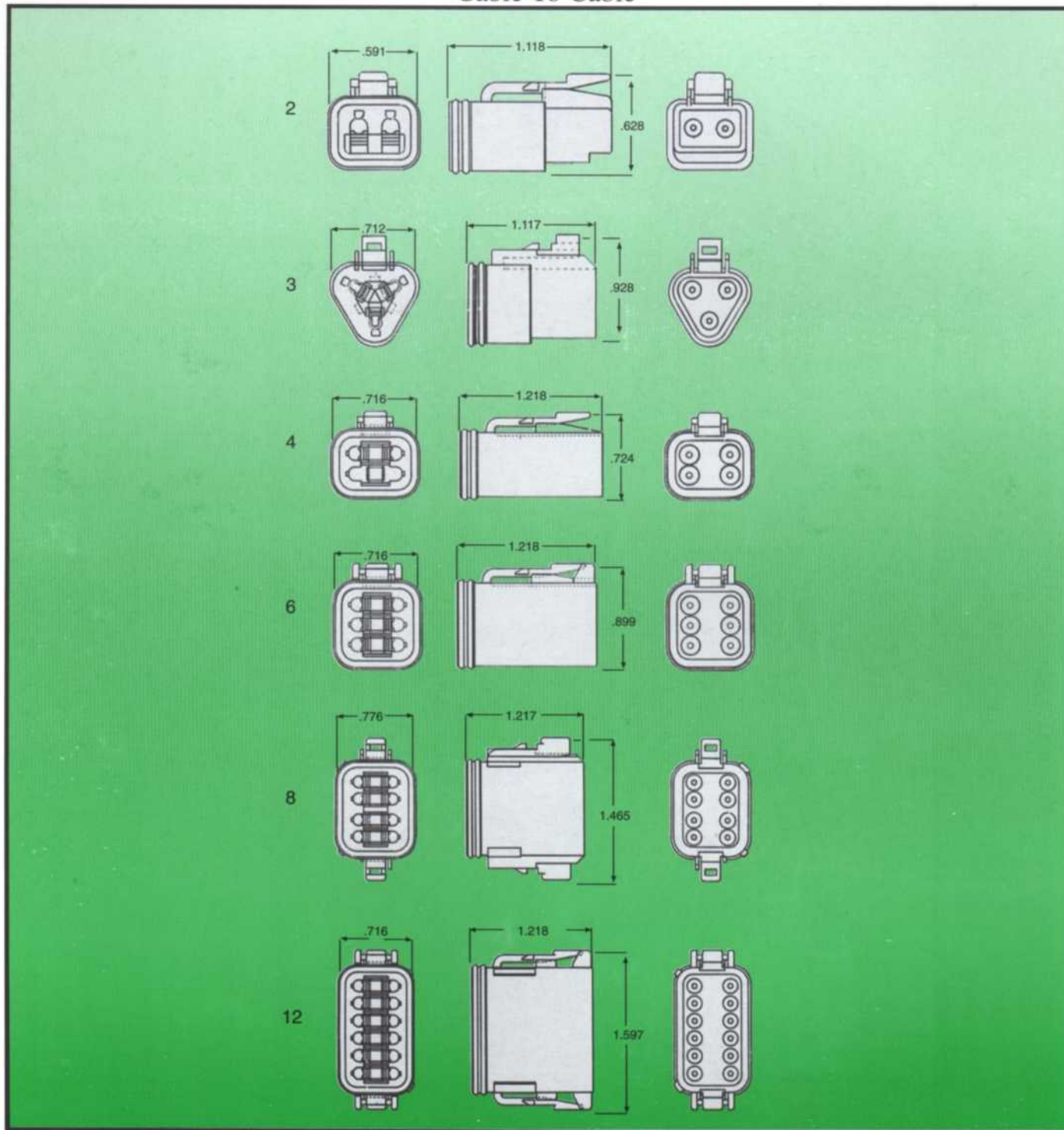

*Specifications may change without notice.
Contact Deutsch IPD at 909/765-2250 for additional information.*



DT Series

Receptacle Cable To Cable

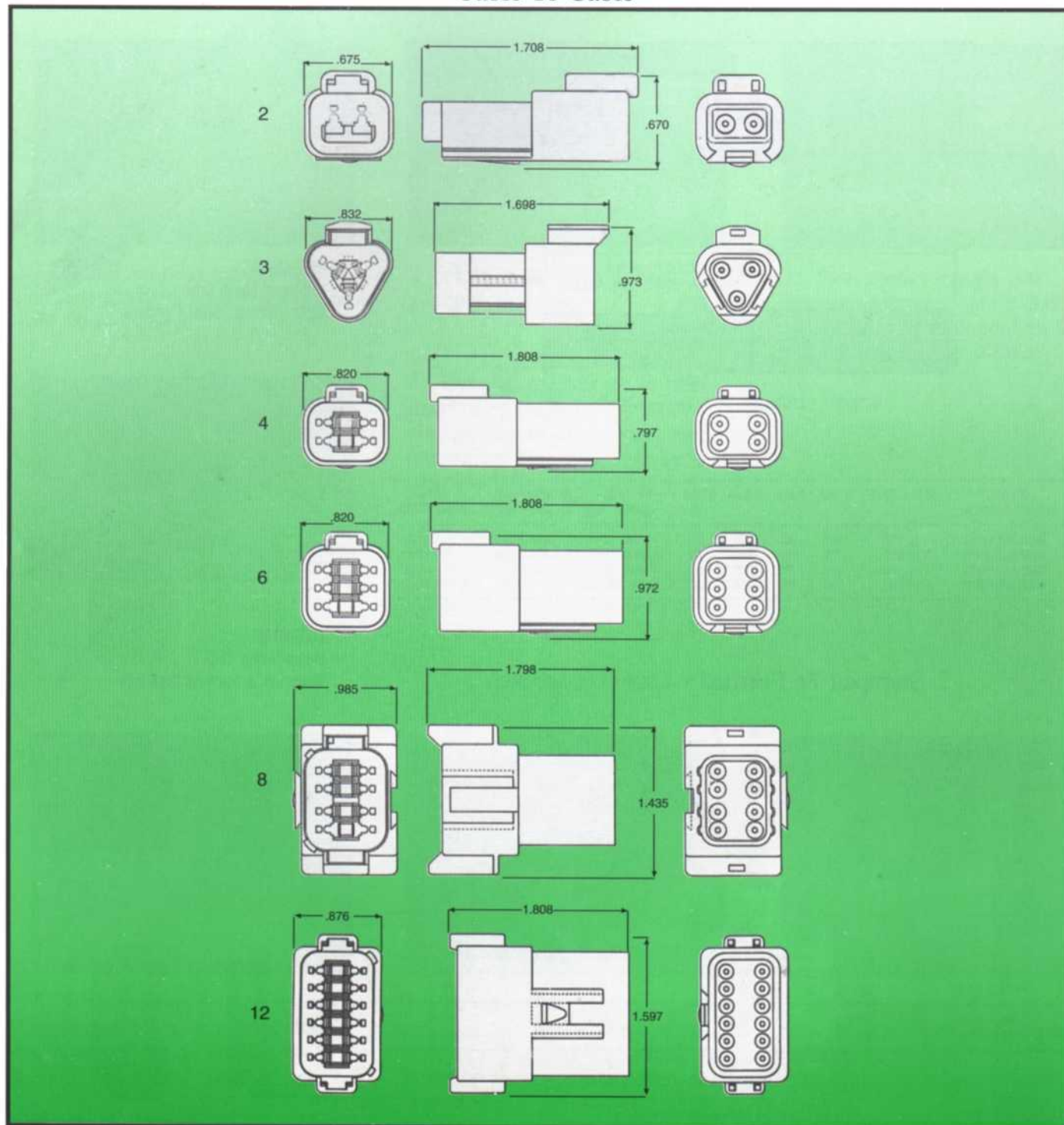

*Specifications may change without notice.
Contact Deutsch IPD at 909/765-2250 for additional information.*



Contacts

Solid - Crimp Type

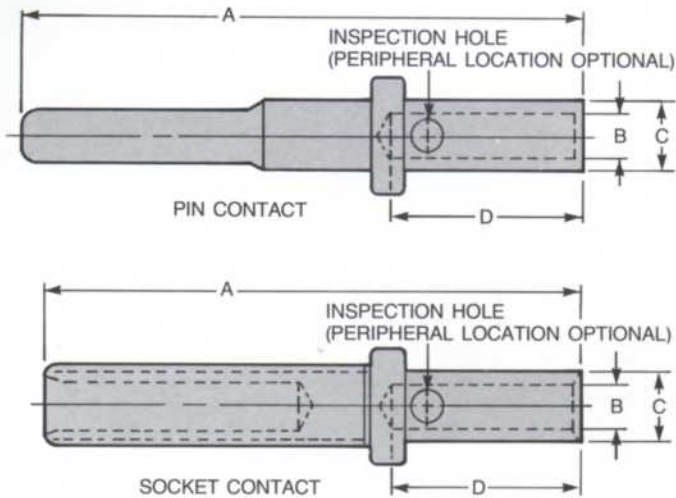

CONTACT PART NUMBER	SIZE & TYPE	A MAX	B MIN	C MAX	D MIN	WIRE GAGE RANGE	RECOMMENDED STRIP LENGTH	HAND CRIMP TOOL
0460-202-16141	16 PIN	.821	.066	.103	.250	16 AND 18	.250-.312	HDT-48-00
0462-201-16141	16 SOC	.759	.066	.103	.250	16 AND 18	.250-.312	HDT-48-00
0460-215-16141	16 PIN	.821	.076	.103	.250	14 AND 16	.250-.312	HDT-48-00
0462-209-16141	16 SOC	.757	.076	.103	.250	14 AND 16	.250-.312	HDT-48-00

Stamped & Formed - Crimp Type

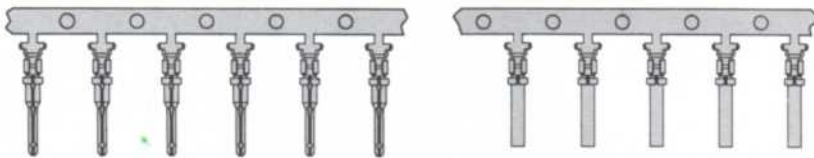

STAMPED & FORMED CONTACT PART NUMBER	SIZE & TYPE	WIRE GAGE RANGE	RECOMMENDED STRIP LENGTH	HAND CRIMP TOOL
1060-16-0122	PIN	16 AND 18	.125-.175	DTT-16-00
1062-16-0122	SOCKET	16 AND 18	.125-.175	DTT-16-00
1060-14-0122	PIN	14 AND 16	.125-.175	DTT-16-00
1062-14-0122	SOCKET	14 AND 16	.125-.175	DTT-16-00

Tooling



HDT-48-00
Universal Hand Crimp Tool
Eight - Indent, Solid Contacts



DTT-16-00
Hand Crimp Tool
Stamped & Formed Contacts

*Specifications may change without notice.
Contact Deutsch IPD at 909/765-2250 for additional information.*



Assembly Contact Insertion



1 Grasp crimped contact approximately (25.4 mm) one inch behind the contact barrel.



2 Hold connector with rear grommet facing you.



3 Push contact straight into connector grommet until a click is felt. A slight tug will confirm that it is properly locked in place.



4 Once all contacts are in place, insert orange wedge with arrow pointing toward exterior locking mechanism. The orange wedge will snap into place. Rectangular wedges are not oriented. They may go in either way.

NOTE: The receptacle is shown - use the same procedure for plug.

Contact Removal



1 Remove orange wedge using needlenose pliers or a hook shaped wire to pull wedge straight out.



2 To remove the contacts, gently pull wire backwards, while at the same time releasing the locking finger by moving it away from the contact with a screwdriver.



3 Hold the rear seal in place, as removing the contact will displace the seal.



DT SERIES

Field Proven Interconnection Systems



DT-Bulkhead MTG. Assembly

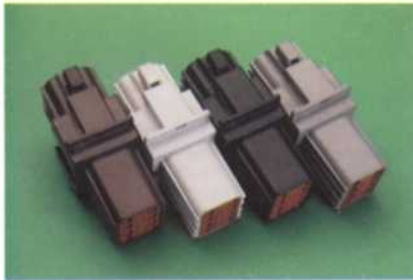

8-Way Modular Assembly

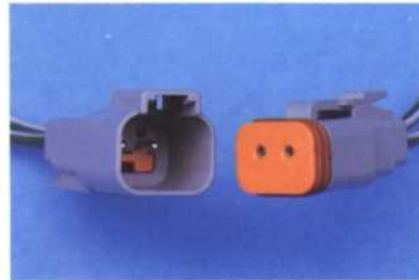

Electronic Transmission Systems



Electronic Hitch Control



Electronic Fuel Injected Engines





Truck - ABS



Farm Equipment



Reefer Systems



Engine Electronics



Generators



DT - Mounting Plates



Light Systems



DEUTSCH

Industrial Products Division

COMMON CONTACT SYSTEM

DEUTSCH COMMON CONTACT SYSTEM

Fundamental to the Deutsch connector series is the principle that all wires are terminated by a single contact system. The only variation in contacts is that dictated by wire gauge. The word "common" describes the Deutsch contact system well. Deutsch contacts, whether solid or stamped and formed, can be assembled into the entire Deutsch connector family. Let's look at the common system of contacts, tooling, processes, and terminations in detail:

COMMON CONTACTS

The basic system uses five contact sizes: 4, 8, 12, 16, & 20. These are the only contacts that an O.E.M. or their supplier need stock no matter what connector is being terminated. Two styles of Deutsch contacts are available - solid crimp types, manufactured by a cold heading process of solid copper alloys. Stamped and formed contacts are manufactured with a series of progressive dies. Both contacts are interchangeable within the connector and are selected based upon the user's application. Stocking costs, engineering costs, and termination costs are all slashed, because the number of evaluations, test procedures, test reports, process standards, drawing notes, etc., are reduced, if not eliminated.

COMMON TOOLING

Two hand crimp tools are used to crimp the five different sizes of contacts to the wire end. For semi-automation to full automation, one universal crimp tool will crimp the volume required for wire termination.

COMMON PROCESSING

Using Deutsch contacts means that the way an O.E.M. supplier attaches a wire to its terminus never varies. This procedural standard allows electrical workers to become highly proficient in terminating Deutsch connectors.

COMMON TERMINATIONS

The selection of Deutsch connectors means that all contact terminations will be the same, thus reducing the chance of errors in the harness system. Performance, reliability, and maintainability are critical to any electrical system. The use of a common contact system eliminates many of the failures reported in harnesses where hundreds of different types of terminations are used. The end result of selecting Deutsch is increased profits and long term performance.



For Regional Information Contact ...

DEUTSCH

INDUSTRIAL PRODUCTS DIVISION

3850 Industrial Avenue, Hemet, California 92545

Telephone (909) 765-2250 • Fax (909) 765-2255